

# ASSEMBLY AND INSTALLATION INSTRUCTIONS

T0561

**WARNING: Turn off the main power at circuit breaker before installing fixture.**  
**AVERTISSEMENT: Coupez la source d'alimentation principale au panneau central de disjoncteurs avant d'installer le luminaire.**

**NOTE: 1. Before installing, consult local electrical codes for wiring and grounding requirements.**  
**2. READ AND SAVE THESE INSTRUCTIONS.**

## Hardware Package (included):

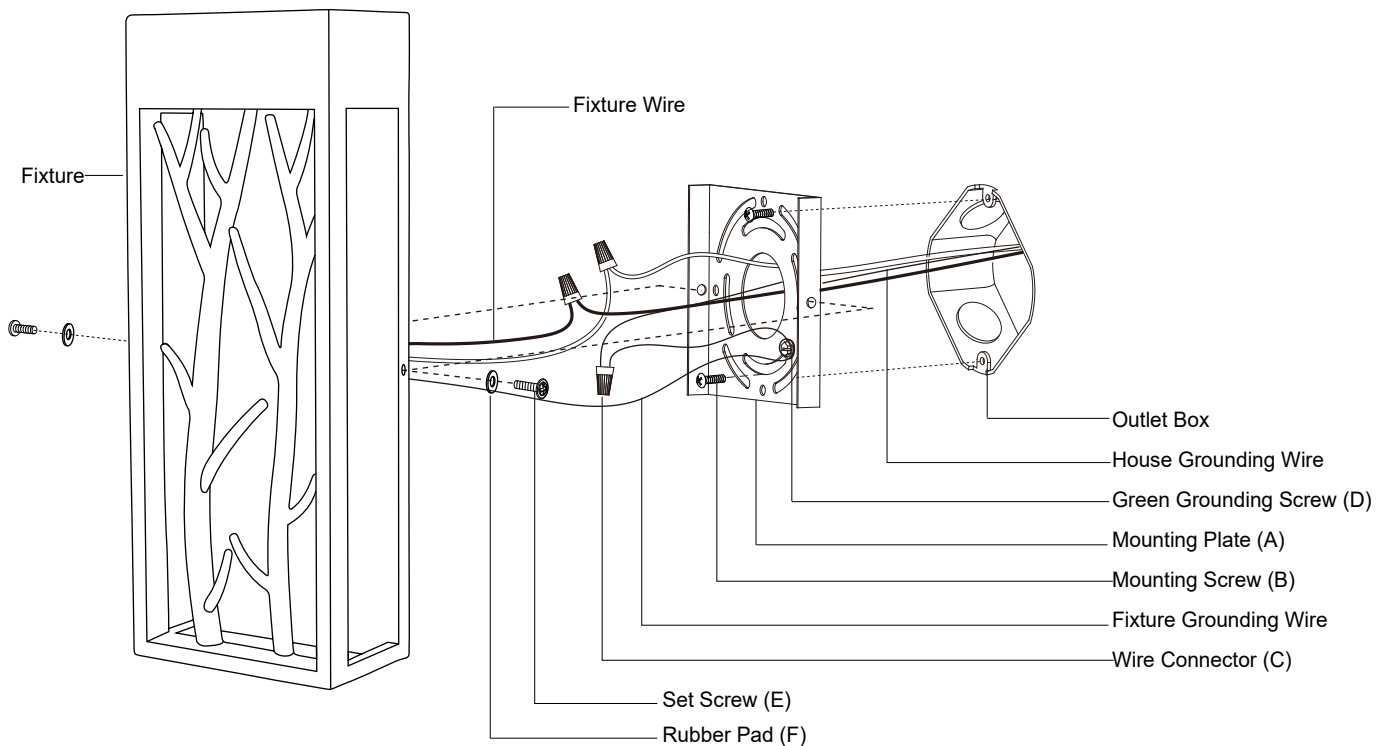
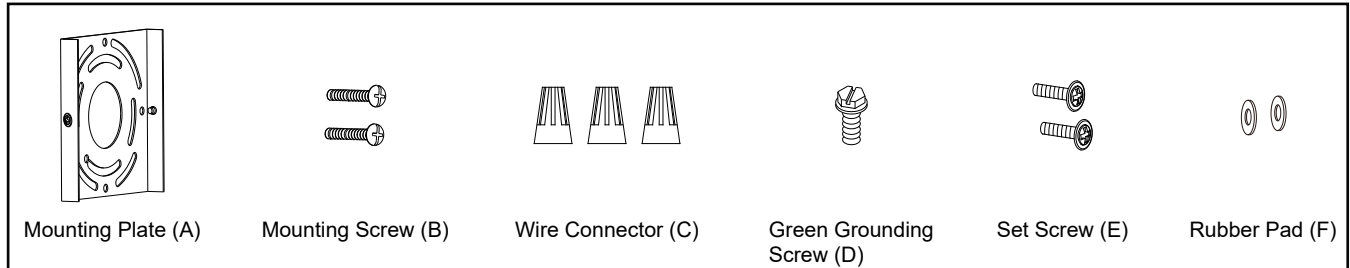

## Installation Steps

Turn off the power at fuse or circuit box.







1. Remove the two set screws (E), the two rubber pads (F) and the mounting plate (A) from the fixture.
2. Attach mounting plate (A) to the outlet box using two mounting screws (B).

3. Pull out the source wires from the outlet box. Make wire connections using wire connectors (C) as follows:
  - Connect the hot wire (usually black insulation) from the fixture to the black wire from the power source.
  - Connect the neutral wire (usually white insulation) from the fixture to the white wire from the power source.
  - Attach the fixture grounding wire (usually green insulation or bare wire) to the mounting plate (A) with the green grounding screw (D), then connect it to the house grounding wire with the wire connector (C).
 Carefully put all of the wires back into the outlet box.
4. Attach the fixture to the mounting plate (A), then secure it with the two rubber pads (F) and the two set screws (E).

**Turn on the power at fuse or circuit box.**

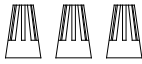
The following parts are available for re-order if damaged or missing.

**Spare Parts List:**

					
Mounting Plate (A)	Mounting Screw (B)	Wire Connector (C)	Green Grounding Screw (D)	Set Screw (E)	Rubber Pad (F)

 **Assembly Kit  
6191MM (1 SET)**

